

FIXED WINDOW

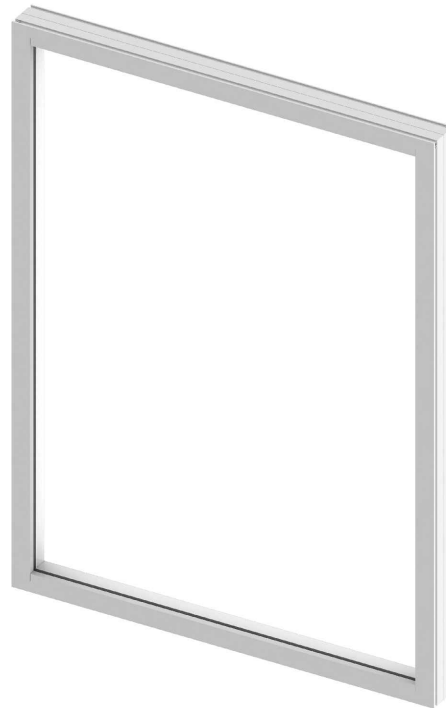
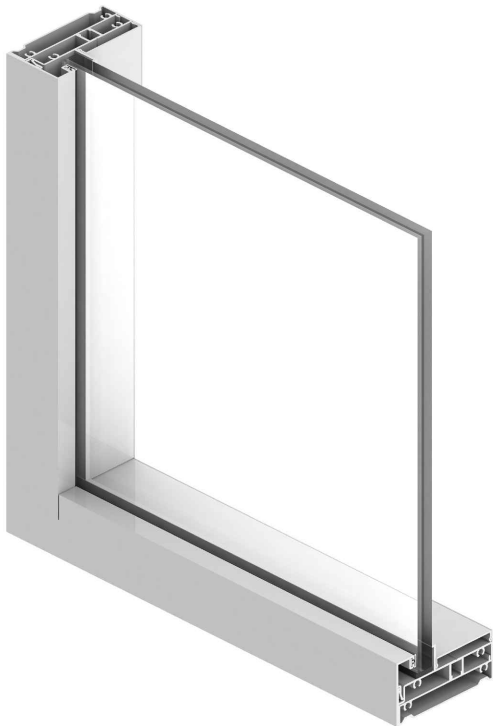

System Description

- Large Missile Impact.
- Pre-assembled & pre-glazed
- Designed for laminated and insulated-laminated glass.

Features

- Architectural shapes available.
- Flush frame adapter & flush frame adapter with fin options.
- Painted and anodized finishes available

Test

- Design load: +80/-80 PSF.
- Water infiltration: 12 PSF.
- Air infiltration: 6.24 PSF.
- NFRC U-Factor: 0.46.

Architectural shapes

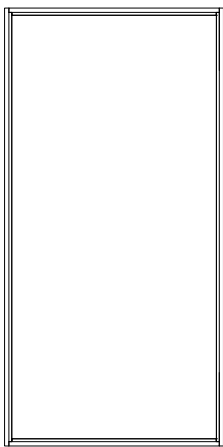

Square

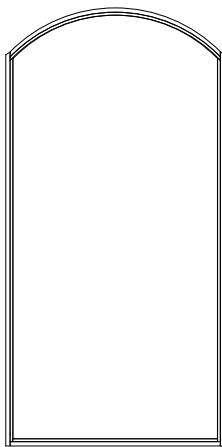

Curve

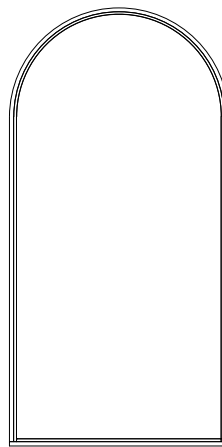

Arch

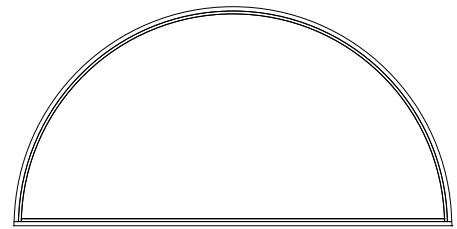

Half moon

Details

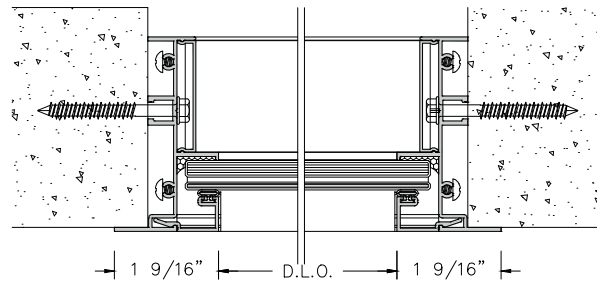
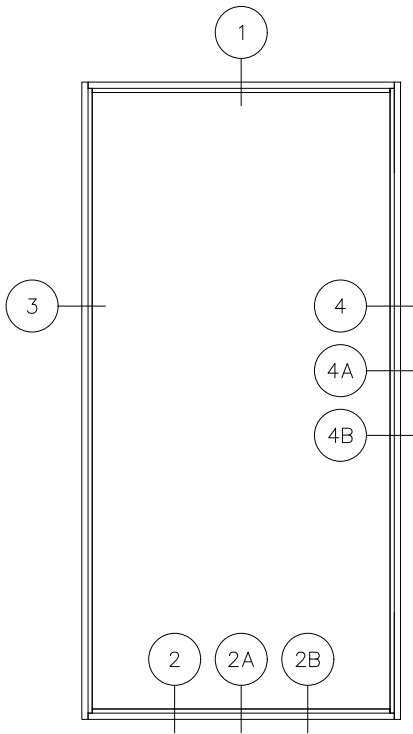

3 LEFT JAMB

4 RIGHT JAMB

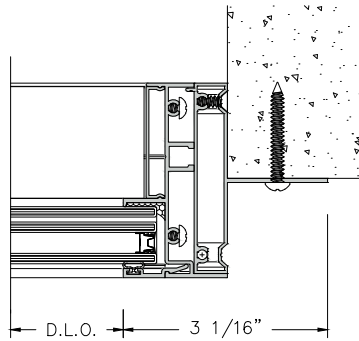

4B RIGHT JAMB FLUSH FRAME ADAPTER WITH FIN

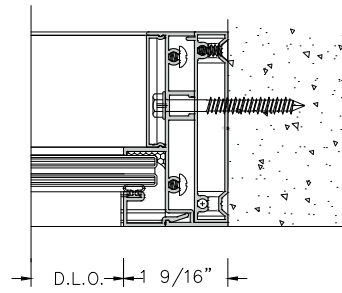

4A RIGHT JAMB FLUSH FRAME ADAPTER

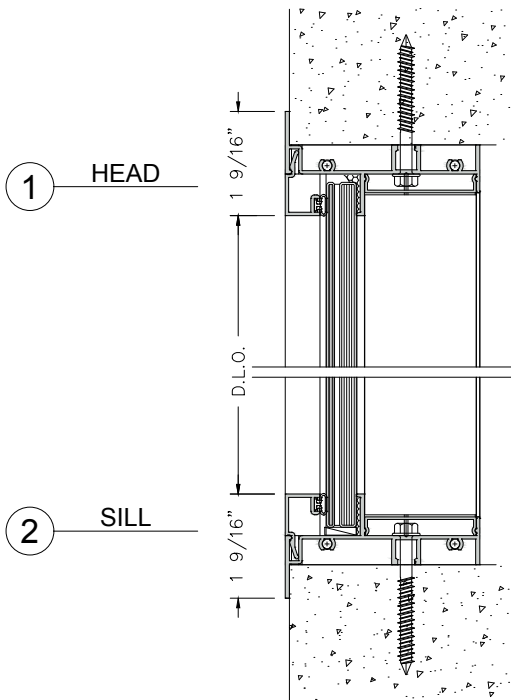

2A SILL WITH FLUSH FRAME ADAPTER

2B SILL WITH FLUSH FRAME ADAPTER WITH FIN

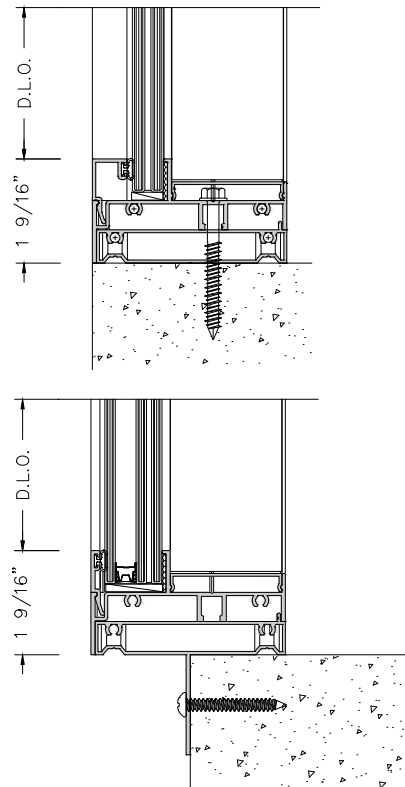

Glazing Options

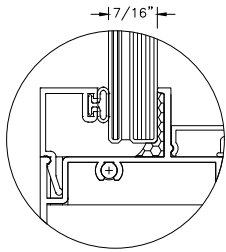

GL1

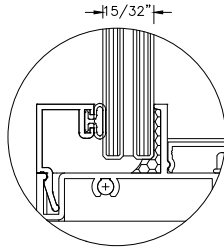

GL2

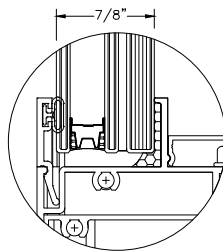

GL3

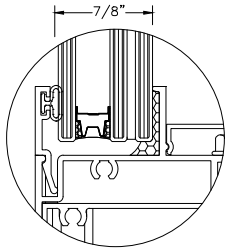

GL4

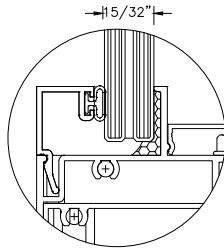

GL5

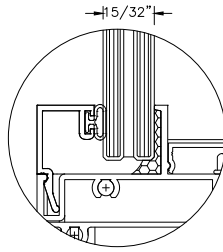

GL6

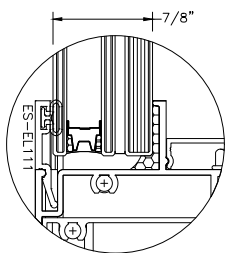

GL7

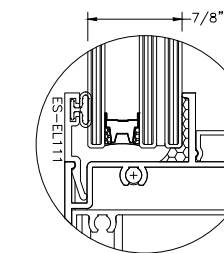

GL8

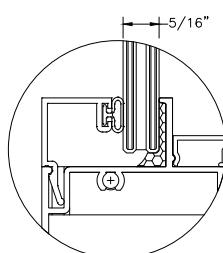

GL9

Large missile impact

GL1:
1/8" Heat Stren'd + 0.075" Interlayer* + 1/4" Heat Stren'd.

GL2:
1/8" Heat Stren'd + 0.090" Interlayer* + 1/4" Heat Stren'd.

GL3:
1/8" Heat Stren'd + 5/16" Air spacer + 1/8" Heat Stren'd + 0.090" Interlayer* + 1/4" Tempered.

GL4:
5/32" Heat Stren'd + 5/16" Aire spacer + 5/32" Heat Stren'd + 0.075" Interlayer* + 5/32" Tempered.

GL5:
3/16" Heat Stren'd + 0.075" Interlayer* + 3/16" Heat Stren'd.

GL6:
3/16" Heat Stren'd + 0.090" Interlayer* + 3/16" Heat Stren'd.

GL7:
5/32" Heat Stren'd + 5/16" Air spacer + 5/32" Heat Stren'd + 0.090" interlayer* + 5/32" Tempered.

GL8:
5/32" Heat Stren'd + 5/16" Air spacer + 5/32" Heat Stren'd + 0.075" interlayer* + 5/32" Tempered.

GL9:
1/8" Heat Stren'd + 0.090 interlayer*+ 1/8" Heat Stren'd.

Interlayer*: Interlayers for all glazing options could be vanceva, saflex, SGP or PVB.

GLASS FINISH: Painted, serigraphy and digital printed.

For more information contact TECNOGLASS® or visit www.tecnoglass.com

Aluminum

ALLOY 6063-T6
ALLOY 6005-T5

For more information about aluminum and finishes consult ALUTIONS®.

Sealant

APPROVED SILICONE SEALS:

WEATHERPROOFING SILICONE:

Used to seal profile unions to avoid air and water infiltration.

- Dowcorning 791(Black-White)

STRUCTURAL SILICONE:

Besides acting as a sealant it is capable to support high loads.This silicone is commonly used to support the glass in facades and hurricane resistant products.

- Dowcorning 983
- Dowcorning 995

Measurements

Maximum sizes:

Width 48"
Height 96"

For more information about dimensions consult System Notice of acceptance (NOA).